

# 3-D WORLD

News For The  
CADKEY/DataCAD  
User

May/June 1990  
Volume 4, Number 3  
Annual Subscription: \$29.95

## Two Independent Developments

### Reverse Engineering on the Human Head??



Physical prototype of aerodynamic safety helmet for speed skiing.

#### High-Tech Speed Ski Helmet!

Shusshh ... Shusshh!!

Skiing is moving to a new height as a sport: pure speed. The goal in speed skiing is to go straight down the hill, as fast as possible, without getting seriously injured. There are no jumps, turns, or gates to clear. Just down the hill as fast as possible! Speed skiing is becoming so popular that it will be introduced as a demonstration sport in the 1992 Winter Olympic Games at Albertville, France.

Individual speed skiers have already produced some impressive records. Speeds of well over 100 mph are now commonplace. The current men's world record is 139.02 mph!

Participants in classic speed sports, such as auto racing and motorcycle racing, understand the need for protective gear, especially protective headgear, and the need to reduce wind resistance. Auto racers and motorcycle racers at least are seated in or on, more or less aerodynamically designed vehicles. And, they have safety-certified helmets available.

What can you do to protect an individual who will

(Continued on page 6.)

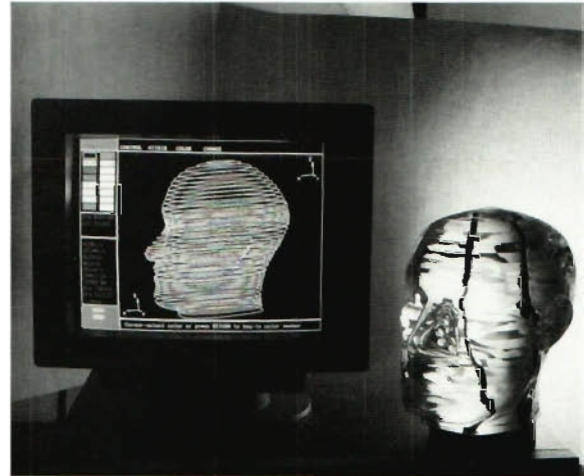

Acrylic model of head for cluster-headache research.

#### High-Tech Headache Research!

"My head is splitting! ... It seems to last forever!"

"Where does it hurt the most?"

"Right about here, behind my eye. ... It feels as if my eye is being pushed out of its socket."

People who suffer from severe headaches know this type of conversation all too well. Headaches, just as any form of pain, come in many varieties. Severe head pain is more than an inconvenient annoyance. It can be physically debilitating. "Approximately 50% of the population have severe, disabling head pain at some time during their

(Continued on page 2.)

#### IN THIS ISSUE:

- ◇ PC MAGAZINE Selects CADKEY<sup>™</sup> EDITOR'S CHOICE Again!!!
- ◇ NDES '90: Enthusiastic Crowds...Rousing Success
- ◇ Architect Designs Hotel During Trade Show!
- ◇ High School Student Invents Rehabilitator
- ◇ La Technothèque -- A Unique Technology Resource in Belgium
- ◇ Trade Show Update
- ◇ CADKEY / DataCAD Training Dates
- ◇ Third-Party News

## Headache Research

(Continued from page 1.)

life," said Ruth Ann Fraser, R.N., Clinical Research Coordinator at the Headache Research Foundation of Faulkner Hospital in Boston, Massachusetts, "and approximately 10% have it as a recurring problem."

Ruth Ann Fraser has embarked on a unique project using CopyCAD™, CADKEY 3™, CADKEY SOLIDS™ and the Perceptor™. She is using software designed for mechanical engineering and for reverse engineering to study a particular headache phenomenon known as *cluster headache*.

### Cluster Headache

A cluster headache is defined as an attack of one-sided, severe head pain that lasts from 15 minutes to three hours. This pain usually occurs around the eye but may spread. Other symptoms that may accompany the headache are forehead and facial sweating, a drooping eyelid, a reddened eye which may produce tears, and a congested nostril. These symptoms only occur on the same side of the head as the pain. These headache attacks can occur up to several times a day, for several weeks or even months, and then they may disappear completely for periods of months or years before returning to the *cluster* period. Cluster headache is primarily a male headache phenomenon, with men afflicted 5-6 times more than women.

### Early Efforts to Develop a Model

During her graduate studies at Carleton University in Ottawa, Canada, and her work as Nurse Researcher and Clinical Studies Coordinator at Ottawa Civic Hospital, Ruth Ann's advisor,

Professor J.F. Campbell, had suggested that she undertake a study of the three-dimensional nature of the location of head pain. In the early 1940's, some initial observations had been made regarding the location of head pain in patients undergoing cranial surgery, but these pain locations were documented using two-dimensional representations. "Pain drawings have proven to be a useful and reliable method of clarifying the perceptions of the clinician attempting to treat pain and its underlying conditions," Ruth Ann said. "However, these have only been done in a two-dimensional setting. "There is a need to develop non-invasive strategies that will help to differentiate the patterns of pain that exist in headache," Ruth Ann said. "We need a new visualization technique to help patients communicate the location and extent of pain as well as the qualities that pain may have in different locations. Pain has not only height and width (area), but also depth (volume). The focus of this study is to provide a reliable technique whereby patients may report the location of their headache in three-dimensional space. If individuals can reliably draw their location of head pain in three dimensions, drawings of head pain from which a volume can be derived may prove to be an effective quantitative measurement of pain and may provide clues as to the underlying mechanisms."

"Trying to find a technique whereby patients could document the location of their headache in 3-D proved challenging. We examined all sorts of alternative ways of doing this." Trying to slice mannequin heads of plastic foam and then cutting out the parts diagrammed by patients was one approach. Inserting plasticene (representing pain locations) into glass heads and trying to find some way of fixing these shapes in space was another attempt. "I thought that with all the computer technology around, surely we could find something that could assist us in doing this more accurately than what essentially amounted to a cut-and-paste model," Ruth Ann said.

"A friend showed me an article from **3-D WORLD**, January/February 1988, entitled **Computer-aided Medicine**, and from then on I attended computer trade shows and computer graphic shows," Ruth Ann continued. "I would simply explain what it was that I wanted to do. Most of the time, people would simply scratch their heads, or the computer *whiz* would tell me that 'Yes, this program could do that...watch.' only to see the failure of trying to convert from 2-D to 3-D."

### Perceptor and CADKEY 3

"In November 1988, I met Wence Daks of CAD WIRE at the

(Continued on page 11.)

## CADZOOM™

The Template Overlay for CADKEY 3.53 which will significantly increase your productivity:

- Make all menu choices from the template
- Reduce Keystrokes
- Integral part drawing file allows for changes and customization
- Right and left handed versions available
- Uncluttered and ergonomically designed

CADZOOM 3.53 (11" x 11") ONLY \$150  
CALL (414) 273-2377



## CADKEY Goes 3 For 3!

# PC MAGAZINE Selects CADKEY® EDITOR'S CHOICE Again!!!

PC MAGAZINE has named CADKEY® **EDITOR'S CHOICE** for the third time since CADKEY first entered the marketplace in 1985. CADKEY is the only CAD system to have achieved this distinction. PC MAGAZINE has published seven comparative evaluations of CAD software since the magazine's founding in 1982. Of the three evaluations published since CADKEY software has existed, PC MAGAZINE has selected CADKEY as **EDITOR'S CHOICE** in all three: 1986, 1988, 1990.

PC MAGAZINE's most recent comparative analysis, **3-D CADD Workstation Tools for the PC Platform**, in its March 1990 issue, presents new developments in CADKEY, such as CADKEY SOLIDS and CADKEY TUTOR. However, the analysis also highlights CADKEY features that appeared prominently in the magazine's earlier studies published in March 1986 and August 1988. Most notable

among these consistently emphasized features are:

- CADKEY's user interface, especially the intuitive logic of its command menus and its economy of keystrokes through the *Immediate Mode* commands.
- CADKEY's 3-D modeling and 2-D drafting capabilities.
- CADKEY's flexible dimensioning capabilities.
- CADKEY's ability to create as many views of a design as the user needs.

In 1988, CADKEY shared **EDITOR'S CHOICE** with AutoCAD™. The fact that in 1990 AutoCAD did not receive the award appears to indicate a comparative deterioration in its technological leadership. PC MAGAZINE notes in its March issue: "But AutoCAD may be showing some signs of age." And further: "But when it comes to 3D work, AutoCAD is not the most capable product, nor is it the easiest to use."

By the thoroughness of its periodic comparative studies of hardware and software for personal computers, PC MAGAZINE has become acknowledged as having a role in the PC industry that is analogous to the role of CONSUMER REPORTS in the world of consumer products.

In fact, this third **EDITOR'S CHOICE** award represents the fifth time that PC MAGAZINE has honored CADKEY. In January 1989, the magazine named CADKEY as one of four finalists for **TECHNICAL EXCELLENCE**, and also designated CADKEY 3™ as **CADD PRODUCT OF THE YEAR** for 1988.

PC MAGAZINE also awarded DataCAD® a perfect score of 4 for A/E/C applications.

**Editor's Note:** Quotations reprinted from PC MAGAZINE, March 27, 1990. Copyright (c) 1990, Ziff Communications Company.

## CADKEY/DataCAD TRADE SHOW UPDATE

See CADKEY 3™ and DataCAD® at these trade shows in 1990:

**AIA '90**, American Institute of Architects, May 19-22, George Brown Convention Center, Houston, TX, Booth #1153.

**A/E/C Systems '90**, Architecture, Engineering & Construction Systems, Jun. 12-15, Georgia World Congress Center, Atlanta, GA, Booth #1848.

Call Danielle Cote, Events Manager, for the availability of discounted admission tickets one month before the show.

## Change For CADKEY Users Mtg.

MN	Minnesota	Meetings:
	Users' Group	Monthly.
	George Heron	
	Tom Loftus	Area
	Anoka Ramsey	served:
	Comm. College	Upper
	11200 Mississippi	Mid-West.
	Bldv.	(612) 427-
	Coon Rapids, MN	2600

## CADKEY/DataCAD at International Trade Shows

**REHABTEC**, Architecture, May 15-20, Barcelona, Spain, FHECOR.

**INFORMAT**, Jun. 4-9, Barcelona, Spain, FHECOR.

**EXPOSER '90 FIRENZE**, Nov. 23-26, Firenze, Italy, ALGOL.



# CK / MOLD™

D E S I G N

**"THE DEFINITIVE TOOL FOR TODAY'S MOLD DESIGNER"**

## \$295

INTRODUCTORY PRICE

- Standard Moldbases Generated Instantly
- Parametric Custom Moldbase Creation
- Standard Mold Component Library
- Works Within CADKEY's Menus (CADL)



For Info and Demo Disk:  
Contact your CADKEY Dealer  
or call Glenn Starkey

**MarkeTech Systems**  
Phone: (708) **356-2600**  
Fax #: (708) 453-6100



## NDES '90: Enthusiastic Crowds...A Rousing Success!

### CADKEY Unveils Four New Products!

CADKEY's **MANUFACTURING SOLUTIONS FAIR** at the National Design Engineering Show (NDES '90), Feb. 26 - Mar. 1, drew such large and enthusiastic crowds that the Chicago Fire Marshal became concerned about people overflowing the booth into the aisles, blocking traffic. During NDES '90 CADKEY introduced four new products: CADKEY SURFACES™, CADKEY RENDER™, CADKEY 386™, and the 1990 CADKEY Applications Guide.

Although the show and conference ran from 10:00 a.m. to 5:00 p.m., visitors arrived early, and visitors stayed late. At 6:00 p.m. every day, show management had to ask visitors to leave the CADKEY booth so that they could close for the night. The crowds were so large that demonstrations, scheduled at half-hour intervals, took place approximately every fifteen minutes. CADKEY personnel, dealers, and the twenty-two third-party developers enjoyed the brisk flow. The "hands-on" Manufacturing Learning Center proved especially popular. One visitor declared that CADKEY's booth was "the talk of the show."

The VECTOR, the super-exotic sports car designed using CADKEY, served as the centerpiece of the booth. (See **3-D**

World, January/February 1990, page 5.) Specific applications of 2-D drafting, 3-D design, solid modeling, surfacing, rendering, stereolithographic prototyping, numerical-control machining in aluminum, sheet metal bending, and other fabrication technologies used CADKEY files of various parts of the car to demonstrate their capabilities.

Talking about the MANUFACTURING SOLUTIONS FAIR afterward, Harold Bowers of HLB Technology (CADJET™) said, "It was a very good show for us, ... a good crowd, ... I worked hard, but I'd do it again in a second." Tom Gray of Arbor Image Corporation (ARBOR SCAN™, LOGO SCAN™, DRAFTSMAN™) commented, "We were full all the time. It was steady. No one walked away. It certainly paid off for us."

The amount of material distributed during NDES '90 gives an indication of the number of people who visited CADKEY's MANUFACTURING SOLUTIONS FAIR. Vector Automotive Corporation distributed 5,000 posters of the VECTOR. CADKEY handed out 5,000 booth guides, 2,000 bags for literature and 1,000 copies of the 1990 CADKEY APPLICATIONS GUIDE.

Scott Wilkman, CADKEY's National Sales Manager, summed up the MANUFACTURING SOLUTIONS FAIR. "It was apparent at NDES '90 that if any company has a handle on mechanical engineering and manufacturing in the 1990's, it is absolutely CADKEY," Scott said. "People usually want to see total solutions, and at the CADKEY MANUFACTURING SOLUTIONS FAIR, they saw just that. As a direct result, CADKEY has now established itself not just as a competitor in the CAD industry, but as an outright leader. And, apparently PC MAGAZINE concurs with its **EDITOR'S CHOICE**."

### Four New Products!

#### CADKEY SURFACES™

CADKEY SURFACES brings another integrated design tool into the CADKEY product family. CADKEY SURFACES features nine types of surfaces: surface of revolution, tabulated cylinders, ruled surfaces, fixed and variable-radius fillets, three-sided surfaces, complex surfaces, and swept surfaces.

Surface modeling is common in large, minicomputer or mainframe-based CAD systems. However, it has only recently become available on microcomputers due to the increased

**CADKEY3.5 USERS**  
See for yourself  
why this  
Geometric  
Tolerancing  
Program is the  
easiest and fastest  
way to draw ANSI  
Y14.5M Symbols.

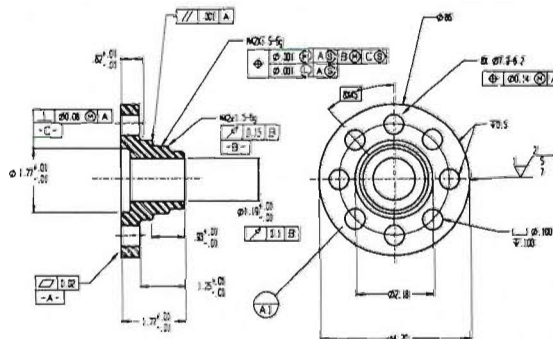

GEODraft Geometric Tolerancing and Drafting Symbols. Only \$249US.  
Visa, MC & Foreign Orders Accepted. Dealer Inquires Welcome.

HLB Technology • PO Box 527 • Blue Ridge, VA 24064 • 703-977-6520

**FREE  
DEMO  
DISK  
AVAILABLE**

**CALL  
703/977-6520**

computing power required.

### CADKEY RENDER™

CADKEY RENDER, the CAD industry's first, commercially available, rendering product based on the Photorealistic RenderMan Interface™, developed by Pixar of San Rafael, California, has begun shipment to DOS-based and UNIX-based customers.

### CADKEY 386™

CADKEY 386, the full 32-bit, 80386-based version of CADKEY 3 (Version 3.55) will begin shipping to customers during the second quarter of 1990. CADKEY 386 can directly address extended DOS memory (above 1 megabyte), and provides dedicated support for the Weitek Abacus™ and the Intel 80387™, floating-point math coprocessors.

### 1990 CADKEY Applications Guide

This latest edition of the CADKEY Applications Guide includes more than 220 third-party software solutions that work directly or indirectly with CADKEY 3 (Version 3.5). The Guide also features, for the first time, more than 30 third-party solutions that work with DataCAD. Contact your CADKEY or DataCAD dealer to obtain a copy.

### Tech Support Update!

Some users have reported problems running Version 3.55 of CADKEY 3™ (a correction release of Version 3.53) with some tablet overlays. For example, some functions on the CADJET™ overlay, such as PAN, DELETE—SINGLE, CHANGE—COLOR, and CHANGE—LINE—L-WIDTH,

can report math errors. This is a problem in CADKEY, **NOT** in the tablet overlay.

Users can work around these problems either by unbinding these macros from their current tablet location and re-binding them elsewhere on the tablet, or by choosing to use Version 3.53 of CADKEY 3.

Users have also reported a problem with POLYLINES which have 10 vertices or a number of vertices that is a multiple of 10. The last x,y,z value is written to 0,0,0. Users can work around this problem by using POLYLINES with any number of vertices other than 10 or a multiple of 10, or by using LINE SEGMENTS.

**Editor's Note:** CADJET is a trademarked product of HLB Technology, Blue Ridge, Virginia.

# Exceed The Speed Limit,

## Want To Fly Through CADKEY™?

Now you can work up to ten times faster with CADKEY™ by making all menu choices direct from the drawing surface. Slip a CADJET™ template over your digitizing pad and forget about memorizing keyboard commands or searching through menus with the mouse.

Access all the standard CADKEY menu commands directly from your digitizing pad with a press of the stylus! You won't believe how much faster you can work. See why so many menu users are making the switch to CADJET. Also define and place your own commands and instructions right on the CADJET overlay eliminating thousands of time-consuming keystrokes. Plus, there's an area for pre-programmed SubTemplates that you design yourself or can purchase ready for use. Spend an hour with CADJET and you'll never go back to the menus again!

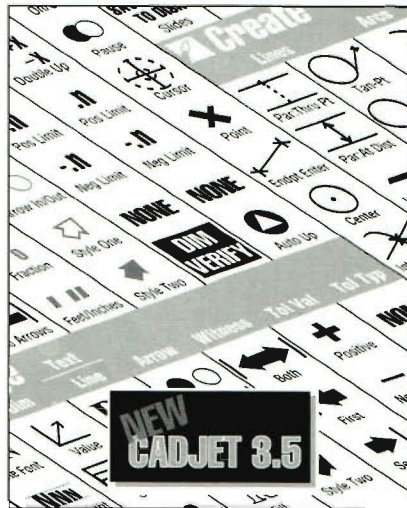

The CADJET template slips right over your digitizing pad allowing you to make all menu choices direct from the drawing surface. Once installed, CADJET loads automatically whenever you boot up CADKEY.

Try CADJET For 30 Days, No Obligation!

Try CADJET 3.5 for thirty days and if you're not completely satisfied, simply return it for a full refund. We won't even charge your account for thirty days. You have nothing to lose!



CADJET 3.5 comes in two sizes: an 11" x 11" for only \$249 and an expanded 11" x 17" for only \$349. Upgrades for current users are only \$25. VISA, Mastercard, and company PO's welcomed. Geometric Tolerancing, General Dimensioning, and Welding Symbol Programs are also available. Call now!

**HLB**  
TECHNOLOGY

*We Make CADKEY Even Better!*

# Call 703/977-6520 Now

For The Name Of The CADJET Dealer In Your Area.

## Speed Ski Helmet

(Continued from page 1.)

be traveling downhill at speeds approaching 140 mph, and whose very own body will be creating the wind resistance? Particularly, how do you help to prevent head injuries? Broken arms, legs, and ribs mend reasonably well. Broken heads and necks do not.

### Speed Skiing Performance Engineering Program

SS PEP, the Speed Skiing Performance Engineering Program, suggests an answer: Start from the beginning; design a new type of helmet to meet the exacting needs of this new sport.

SS PEP is a non-profit organization dedicated to implementing new technology to benefit speed skiers. The organization includes participation by key members of the United States Speed Skiing Team and their coach, Steve McKinney. SS PEP also has several corporate sponsors, among them, Bell Helmets, CADKEY, INC., Fastcut NC Services, GRiD Systems Corporation, Hewlett Packard Company, RLS Enterprises, Structural Research and Analysis Corporation, and Zenith Data Systems.

### Starting at the Beginning

To SS PEP, starting at the beginning to design a safe aerodynamic helmet meant to start with the human head, and design a helmet around it.

Steve Gubelmann and Braxton Carter of SS PEP first met CADKEY when they visited the CADKEY booth at a trade show in San Diego, California, in July 1988. They did not have any

experience with computer-aided design, but they asked some intriguing questions about using CAD to produce new types of ski equipment specifically designed for speed skiing. Eighteen months later, they have begun to turn what appeared to be *far out* ideas into practical reality under impossible deadlines. SS PEP's primary concern is and has always been speed with safety.

CADKEY became involved with SS PEP's helmet project on December 4, 1989. Steve Gubelmann explained to Gary Magoon, Director of Manufacturing Systems, that SS PEP's project would require genuine innovation, but at the same time

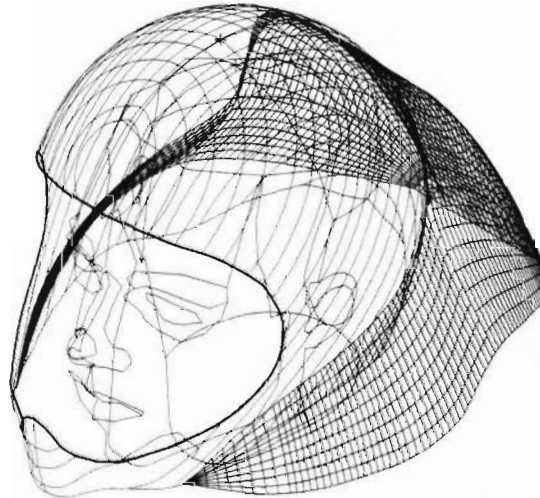

*Illustration of the head data, safety-certified helmet data, and aerodynamic helmet data superimposed on each other. Notice how the data suggests the design of the fairing.*

it must be economically feasible. Taking advantage of existing technology in safety-certified helmets would help to make the project economically feasible. SS PEP had considered using the SR2 alpine-skiing helmet, manufactured by Bell Helmets, as its core helmet because it has already been certified to the most demanding safety standard ever put forward for ski helmets. However, an alpine helmet does not have the aerodynamic design that speed skiing requires. Steve

Gubelmann, Braxton Carter, Gary Magoon and Ujjwell Trivedi, also of CADKEY, took the safety-certified SR2 helmet and an aerodynamically sound, but non-certified helmet currently used in speed skiing as models and set to work. Their target was to have a physical prototype helmet manufactured and delivered to Steve McKinney, the coach of United States Speed Skiing Team, for evaluation, in time for the speed-skiing race in Kirkwood, California, February 22-26, 1990.

### CopyCAD, CADDInspector, and CADKEY 3

Ujjwell used CopyCAD™ and the Brown & Sharpe MicroVal™ Coordinate Measuring Machine to digitize the aerodynamic, Darth Vadar-like outer helmet. Gary also used CopyCAD and the MicroVal to digitize the Bell SR2 as the inner safety helmet.

Gary then used a personally modified version of this reverse-engineering technology to collect accurate three-dimensional data of a human head, his own. Using elements of CADKEY's CADDInspector™ software, which is part of the CopyCAD system, and a Polhemus Isotrak™, a hand-held, three-dimensional digitizing stylus that uses a magnetic field to obtain x, y, and z coordinate data, Gary and his wife Suzanne digitized his head. (The Isotrak is manufactured by Polhemus Incorporated of Colchester, Vermont.)

The three sets of three-dimensional data collected were transferred into CADKEY 3™ as individual part files. Gary created a fourth part file in

(Continued on page 15.)

# Myth #1

**"Engineers don't care what the drawings look like, as long as they're accurate."**

Introducing precision-crafted fonts for CADKEY users who don't fit the mold.

HLV  
ABCDEFGHIJKLMN  
OP  
abcdefghijkl 123456789

AVG  
ABCDEFGHIJKLMN  
OP  
abcdefghijkl 123456789

ENG  
ABCDEFGHIJKLMN  
OP  
abcdefghijkl 123456789

HLV & AVG font sets include solid Thin and fillable outline Light, Medium & Bold variations.

ENG handletter set includes solid Thin and Light & Heavy Chisel variations.

Arcdraft America precision-crafted fonts are available by mail or from your CADKEY dealer for just \$149 per set. Additional station sets are just \$39 each. Give us a try! Your drawings never looked so good.

**Arcdraft  
America**

1560 Twin Lakes Circle, Tallahassee FL 32301

1-904-877-3047

**1-800-447-4165**

Dealer Inquiries Invited

## DataCAD<sup>™</sup> Introduced Into France At MICAD '90 Architect Designs Hotel During Trade Show!

Can anyone imagine using a busy trade show booth as a place to do serious design work? Jacques Lioret, a professional architect, did just that for a while during MICAD '90, February 13-16, 1990, in Paris, France!

Jacques and Michael Piekarz, CADKEY's European Regional Manager for A/E/C Products, provided the formal introduction of CADKEY's DataCAD<sup>™</sup> product line into the French market. Instead of doing a typical demonstration in the booth, Jacques actually worked on the design of a hotel that he has been commissioned to undertake, and graciously answered questions from visitors as he worked. He only stopped when the number of questions from interested visitors became so frequent that they intruded into his design work.

Jacques Lioret is Managing Director of ABACAD, S.A.R.L., Informatique-Construction-CAO headquartered in Neuilly-sur-Seine, a suburb of Paris. He has used CADKEY 3<sup>™</sup> in his architectural work for two years. He was introduced to DataCAD only one month before MICAD '90. Jacques became so enthusiastic about this true, three-dimensional software for architects and construction professionals that he has decided to adopt it in his architectural business. And, he eagerly welcomed the opportunity to participate in DataCAD's official introduction into France at MICAD '90.

Jacques also demonstrated DataCAD in ABACAD's booth at CONSTRUCTIQUE, an A/E/C show in Paris, March 23-27, 1990.

**Editor's Note:** The July/August issue of 3-D WORLD will include an illustration of the completed hotel that Jacques Lioret was designing at MICAD '90.

## THIRD-PARTY NEWS

### ROOFER<sup>™</sup> Makes Building a Roof as Easy as Choosing Three Points!

River City Software, Inc. of Jacksonville, Florida, introduces ROOFER<sup>™</sup>, a menu-driven roof-design macro for use with DataCAD<sup>™</sup>. ROOFER allows an architect to design complex roofs in seconds. The architect can easily design many, different roof configurations for the same building, and choose the one that looks best, or save them all for alternate elevations.

ROOFER creates full three-dimensional roofs with user control of the roof type, pitch, overhang, plate height, thickness of the components of the roof system, and even what detail is to be shown. ROOFER includes seven of the most popular types of roofs: gable, hip, hip-gable, Boston hip, gambrel, mansard, and shed roof. It also includes selections for facias, soffits, and end filling.

Through the use of the automatic tie-in feature, ROOFER allows a new section of roof to be *pulled back* into an existing roof surface. This makes dormers, porticos and unlimited roof configurations possible.

ROOFER can be used with any DataCAD system. It does not require DC Modeler<sup>™</sup>.

ROOFER sells for \$149.00.

For additional information on ROOFER and for a special introductory offer, contact River City Software, Inc., 9570 Regency Square Boulevard, Suite #325, Jacksonville, FL 32225-8100. Telephone: (904) 721-8246.

## Advantage Standards I- and Details II- Add Value to Architect's System

Symtech, a division of Richard Kent, Architects, Irvine, California, a CADKEY Exclusive Solution Partner, offers two products, Advantage Standards I™ and Advantage Details II™, developed by active professional architects, to provide architectural CADD standards and an architectural data base to DataCAD® users.

### Advantage Standards I

Advantage Standards I supplies industry-standard conventions

for defining the names of drawings and of layers within drawings, colors, pen weights, text, and the variables of setting with which architects must deal for a smooth and efficient use of CADD. "Advantage Standards I is most beneficial to brand new DataCAD users," said Dick Kent of Richard Kent, Architects. "It saves them from having to create their own default drawings for floor plans, site plans, exterior elevations, etc."

Advantage Standards I consists

of two disks filled with pre-bordered, pre-named, layered and scaled default drawings, accompanied by one, 8.5" x 11", three-ring binder containing hard copies of the drawings, descriptive material and helpful forms.

The default drawings are intended to reside in a default subdirectory within the DataCAD system. However, they can also be kept separately on their own disks.

# FastSURE

## Affordable Surfacing Technology That's Easy To Use!

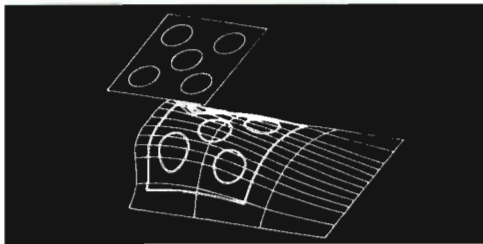

*Entity projection onto a surface simplifies otherwise extremely difficult modelling procedures with precise control. No more time consuming approximations.*

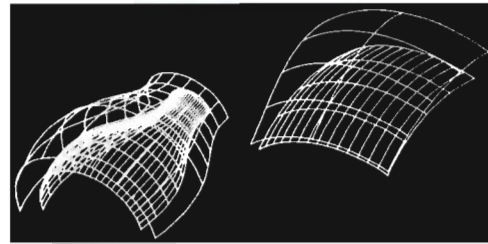

*Constant and tapered offset surfaces are provided. Tapers can be linear or cubic blended, and may be bi-directional. Offsets simplify roughing procedures in CAM packages.*

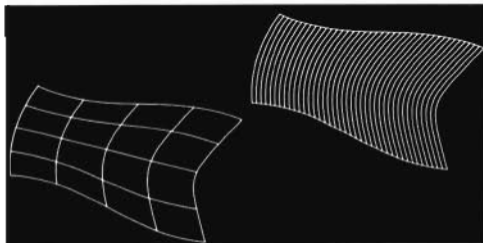

*User-definable flow curve density improves accuracy of surface representation into PC-based CAM systems that are incapable of supporting true bi-cubic surface definitions. IGES and direct translators are also available.*

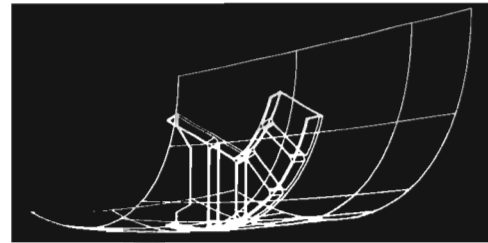

*Mold-line parts inherit surface curvature from accurate planar cross-sections. Production and inspection of these parts benefit greatly from a uniform surface database.*

## Complex Free-form Surfacing Power For CADKEY!

### FASTCUT NUMERICAL CONTROL SERVICES

550 Carson Plaza Drive, Suite 107, Carson, California 90746  
(213) 329-4449 • (800) 752-2457 • FAX (213) 329-5202



Advantage Standards I sells for \$189.00.

## Advantage Details II

Advantage Details II is a CADD library of more than 400 architectural details stored as DataCAD symbols on floppy disks that can be purchased individually or as a complete set of 31 disks and two, 8.5" x 11", three-ring binders containing hard copy of the details. The architectural detail divisions (templates) follow the Construction Specifications Institute (C.S.I.)'s format. In each section of the binders, the hard copy of the C.S.I. numbered divisions of details is followed by the specific disk containing those details and templates.

The details include concrete, metal, wood, industrial, and residential detailing. All the details are drawn to a single scale to eliminate any confusion of enlargements, text size, and

mult-scale plotting. DataCAD users can customize these details to fit their own specific needs.

Advantage Details II provides a convenient solution to the problem of maintaining the most up-to-date version of details. It is not necessary to use valuable hard-disk space on an architect's individual personal computer to store all of these details. However, architects working in a networked configuration can store and access these details on a file server.

The price of Advantage Details II ranges from \$98.00 to \$198.00 per floppy disk depending upon the number of details an individual buys. A complete set costs \$2,800.00 This amounts to \$7.00 per detail, a small percentage of the cost to produce them in house.

For additional information about Advantage Standards I or Advantage Details II, contact

Todd van Etten, Symtech, 17748 Skypark Circle, Suite 165, Irvine, CA 92714. Telephone: (714) 261-8321. FAX: (714) 261-1310.

### New DataCAD Users Group

PA	DETAIL	Meetings:
	DataCAD	Monthly.
	Enthusiasts	
	Trading Advice	Area
	In Lancaster	served:
	Terry Bergen	South
	ComputerLand	Central
	of Lancaster	Penn-
	1360 Harrisburg	sylvania.
	Pike	(717)291-
	Lancaster, PA	2111



**Roof Builder™**  
The Quick & Simple Way  
of Creating 3D Roofs  
within DataCAD™  
*You give it a slope - it calculates  
the Z-heights as you draw*  
Call People Software (916)644-8841

# Why you should contact your CADKEY Dealer...

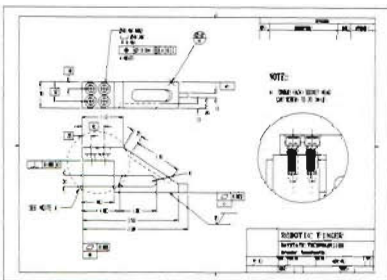

### "A CADKEY® Integrated Enhancement"

If you are a mechanical designer or engineer you need DRAFT-PAK. Don't take our word for it, your CADKEY dealer can show you first hand how to become more productive with your CAD system.

DRAFT-PAK will save you valuable design and detailing time, with CADKEY, through powerful 2D and 3D parametric programs, built right into the CADKEY menu. Several of DRAFT-PAK's functions are listed below:

- automatic drawing of features, holes, slots, pockets, fasteners, screws, nuts and bolts
- mechanical elements such as gears, racks and springs
- geometric tolerancing and dimensioning symbols
- automatic feature labeling, surface finish symbols, and more ...

*Please contact your CADKEY/DRAFT-PAK dealer  
for a demo or further details.*

**BT** BAYSTATE TECHNOLOGIES

30 Westview Road, Worcester, MA 01602  
Phone: (508) 755-1172 • FAX: (508) 795-1301

## High School Student Invents Arm Rehabilitator!

by Sandra Rimetz

Esther Simpson is a senior at St. Peter-Marian High School in Worcester, Massachusetts, who is concentrating on math and science. In the Fall of 1989, Esther's Computer Science teacher, Ms. Dawn Van Riper, and CADKEY, INC. began an educational grant program at the school. Computer-aided design with CADKEY™ will become an integrated part of in the Computer Science curriculum at the school during the 1990-1991 academic year, but by that time Esther will have graduated. This did not stop her from learning CADKEY. With Ms.

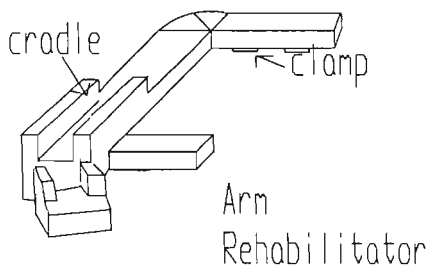

*Esther Simpson's original CADKEY part file of her arm rehabilitator.*

Van Riper's enthusiastic approval, Esther began to learn CADKEY by herself when she had free time. Without any instruction in drafting or in CAD, and without even reading the CADKEY manual, Esther began to teach herself some of the basics of CADKEY by playing with lines, rectangles, and arcs.

In August 1989, Esther's grandmother had suffered a severe stroke in the left side of her brain that left her unable to speak, and that disabled the right side of her body, but it did not paralyze her. Physical

therapy has restored some of the use of her right leg. Her grandmother can now walk short distances with the aid of a walker. Speech therapy has had some limited success, too. However, her grandmother's right arm showed no progress at all. While tinkering with CADKEY, and with her grandmother's disability in mind, Esther began the design of an arm rehabilitator that would allow her grandmother to exercise her right arm by using her left arm. "The whole picture developed from an ordinary box," Esther said.

Esther received encouragement from several people, among them, John Ryan of CADKEY's Technical Support Group who plotted her part files for her, and Dr. Arthur Lerit, her Physics teacher.

She revised her CADKEY part file several times. "After some more revisions, I built a small Lego™ model of my plan." The arm rehabilitator that Esther designed has a support and two cradles, one for the arm and one for the hand, joined by strap hinges. It is portable, and the support piece can be clamped to any table.

Esther then took her model a step further. She measured her grandmother's arm, and built the arm rehabilitator to custom fit these dimensions from wood, foam rubber, cloth, hinges, screws, and glue.

"From articles that I have read on rehabilitating the arm, I have found that, in order to re-educate the arm properly, you must use three of the body's systems together," Esther continued. "My machine forces the skeletal system to work with the soft-

tissue system and the neurological system. This is done by resting the arm in the padded cradle, and using the working arm to move the other arm in a gentle sideward motion. In doing so, the bones act as braces for the muscles to hold, while they exercise and regain the ability to move. At the same time, the nerves can attempt to tell the brain that the arm is functional, but needs exercise and the correct instructions."

Esther's manufacturing techniques were limited by the materials available to her. She admits that using different materials, such as molded

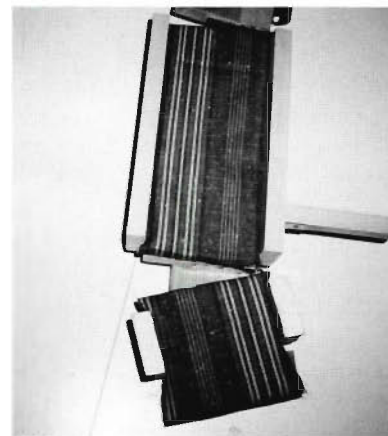

*Esther Simpson's finished arm rehabilitator.*

plastic, would allow the arm rehabilitator to be designed to make it usable for either arm.

Esther's grandmother now has an arm rehabilitator, and Esther has an application for a patent pending. However, Esther's involvement with CADKEY does not end here. Next year, she will enter her freshman year at Worcester Polytechnic Institute which incorporates CADKEY into its Mechanical Engineering program. We wish her success!

**Editor's Note:** Sandra Rimetz is Manager of Technical Publications, CADKEY, INC.

## Headache Research

(Continued from page 2.)

Canadian Computer Show in Toronto," Ruth Ann said. Wence Daks recommended that she use a combination of the Perceptor and CADKEY. The Perceptor is an interactive three-dimensional digitizer invented and manufactured by Micro Control Systems in 1984, before the arrival of CADKEY software. (CADKEY software entered the marketplace in 1985, and Micro Control Systems changed its name to CADKEY, INC. in 1988.) One of the Perceptor's applications is reverse engineering. Ruth Ann continued, "If I had a model of the human head that was sectioned in horizontal slices, Wence assured me that, with the Perceptor, I could digitize the model of the head as well as the 2-D drawings that patients would make on each slice. Then, using CADKEY, I could merge these pattern files to produce a 3-D drawing of headache location. Also, using the Solid Synthesis abilities of CADKEY, I would be able to compute the mass properties (volume and centroid) of these 3-D solids that represented pain location and distribution. This is what I had been looking for!"

The Perceptor, CADKEY 3, and CADKEY SOLIDS now entered Ruth Ann's project. In the meantime, she had moved from Carleton University and Ottawa Civic Hospital to the Headache Research Foundation at the Faulkner Hospital in Boston where the Director, Dr. Egilius L.H. Spierings, was very interested in her work. Ruth Ann obtained the Perceptor and CADKEY through CAD WIRE in March, 1989. "Wence Daks and Charlie Kovacsazy were very helpful to me, even providing me with a plate that had been custom made for the Perceptor that would allow me to stabilize my work," she said. "They had the technical knowledge and skill to grasp what I needed and wanted to do, and then they were able to explain that to me."

### Realistic Model

Ruth Ann's goal was to digitize an anatomically correct, three-dimensional

(Continued on page 12.)

## THIRD-PARTY NEWS

### WLDSYM™ (Version 4.0)

#### Released As Shareware

Paul E. Leth, owner of Specialty Services and developer of WLDSYM™, has announced the release of WLDSYM (Version 4.0) as shareware. WLDSYM became available on CADKEY's electronic bulletin board and on the CADKEY Forum of CompuServe™ Information Service as of April 11, 1990. As shareware, WLDSYM (Version 4.0) may be freely copied and distributed throughout the CADKEY-user community at no cost to the user.

"Since WLDSYM (Version 1.0) was first released in February 1988," Paul said, "users have been impressed by the program's speed, ease of use, and flexibility. Literally thousands of welding-symbol configurations can be quickly constructed using the easy-to-follow on-screen menus."

WLDSYM (Version 4.0) is a full-featured release, lacking only a tablet interface introduced by HLB Technology.

Paul encourages CADKEY users who find WLDSYM useful to register their copy with Specialty Services. Registered users will receive a complete copy of documented source code for WLDSYM. This ensures that a user will continue to be able to use WLDSYM as CADKEY versions develop, without any upgrade fee. Users may also modify their own copy of WLDSYM to add or modify features to fit their own specific needs.

Now that WLDSYM has become shareware, if a CADKEY user does not have access to a modem and/or if there is no copy of WLDSYM (Version 4.0) available to her/him locally, he/she can obtain a copy of WLDSYM from Specialty Services for \$5.00. This fee covers the cost of the floppy disk, mailer, postage, and handling. (The fee is slightly higher for shipment outside the United States due to higher postal charges.) WLDSYM (Version 4.0) is free of charge.

For additional information about this offer, or to obtain a copy of WLDSYM (Version 4.0), contact Paul Leth, Specialty Services, Route #3, Box 273, Estill Springs, TN 37330. Telephone: (615) 967-8499.

---

### CADKEY Provides Training for Soviet Refugees

Twelve Soviet engineers and architects, who came to the United States as refugees in search of religious freedom, have also found help in finding employment, through an evening training program in computer-aided drafting and design provided by volunteers at CADKEY, INC. All of the refugees now live in the metropolitan area of Hartford, Connecticut. The five training sessions took place, free of charge, at CADKEY's World Headquarters in Manchester, between January 30 and February 15, 1990.

(Continued on page 17.)

## TRAINING SCHEDULE AT CADKEY, INC.

We have Training dates scheduled through June, 1990. Please call Lisa Varvelli in the Product Support Department to register (203) 647-0220.

Course	May	June
Introduction to CADKEY	30 - 2	25 - 27
Advanced Geometric Modeling	3 - 4	28 - 29
Introduction to CADL		11 - 13
CADKEY SOLIDS	31 - 1	
Introduction to DataCAD	21 - 23	25 - 27

### CADKEY/DataCAD Training In U.S. & Canada

Many authorized CADKEY and DataCAD Training Centers have scheduled courses in addition to the training available at CADKEY's world headquarters here in Manchester, CT. The following is a list of who is doing what, where, and when:

State	CTC	Location/Contact	Course	Dates
Ala.	Auburn University	O.D. Smyth Hall Auburn University, AL Bret Smith (205) 844-2372	<i>Intro. to CADKEY</i>	Jun. 11-13
		The Beville Center 1011 E. Broad St. Gadsden, AL Scott Schultz (205) 547-5782	<i>Intro. to CADKEY</i>	Jun. 11-13 Aug. 27-29
Calif.	CAD MicroSystems	11936 W. Jefferson Blvd. Suite A Culver City, CA Monica Hunter (213) 391-7226	<i>Intro. to CADKEY</i>	May 8-10
			<i>CADKEY</i>	Jun. 5-7
			<i>Advanced CADKEY</i>	Jul. 11-13 May 16-17
			<i>CADKEY</i>	Jun. 12-13 Jul. 18-19
			<i>CADKEY SOLIDS</i>	May 22 Jun. 14
	Consulting Services International	7311 Van Nuys Blvd. Van Nuys, CA Bob Messamer (818) 994-8881	<i>CADL</i>	Jul. 24 Jul. 26
			<i>Intro. to CADKEY</i>	3rd wk. each mo.
			<i>Advanced CADKEY</i>	Scheduled on request.
	Poelman's Design Service	901 Campisi Way, #360 Campbell, CA Mike Poelman (408) 377-3585	<i>Intro. to CADKEY</i>	May 29-31
			<i>CADKEY</i>	Aug. 28-30
<i>CADKEY SOLIDS</i>			Jul. 24-26 Sep. 25-27	
<i>CADL</i>			Jun. 26-28	
Ukiah High School	1000 Low Gap Rd. Ukiah, CA Jim Howlett (707) 463-5253, x284	<i>Intro. to CADKEY</i>	May 4-6 Sep. 7-9	
Colo.	CADKEY Colorado	4285 S. Ulster St. Pkwy. Suite 402 Denver, CO Barbara Yonkers (303) 770-2024	<i>Intro. to CADKEY</i>	May 1
			<i>CADKEY</i>	Jun. 5
			<i>Advanced CADKEY</i>	May 8
			<i>CADKEY</i>	Jun. 12
			<i>CADL</i>	May 15
				Jun. 12

## Headache Research

(Continued from page 11.)

model of the human head. She planned to use the data in this 3-D CAD model to have a physical model of the head shaped and assembled from precisely machined slices, or plates, of a clear plastic-like material. Each slice would be one centimeter in thickness and would have a precisely drilled hole in the center. The slices would be assembled as a head, on a base with a vertical dowel, by sliding each slice, one at a time, down the dowel, from the neck to the top of the head, similar to a child's ring-stacking toy. (Later, during the actual manufacturing of the head, Rich Millett of SANTIN ENGINEERING, Beverly Massachusetts, suggested using two dowels for sliding each slice into place. Two dowels would keep each slice in its proper place and would give stability to the head model.) When a patient would use the model to identify the location of his headache pain, each slice could be physically removed from the model to get to the level of the head where the patient is experiencing the pain.

Ruth Ann purchased an anatomical model of half of a human head to provide anatomically accurate reference points for pain location. This model outlines the skull, major blood vessels, musculature, and intercranial structures, but needed a coating of play dough to create a scalp effect. She digitized the model using the Perceptor, in slices 1/4-inch thick, with approximately 70 points per slice. But, she ran into a problem with respect to verifiably repeatable accuracy of some of the points.

### CopyCAD and CADKEY 3

With the help of Gary Magoon and Ujjwll Trivedi of CADKEY, Ruth Ann digitized the head model again, using CopyCAD with Brown & Sharpe's Microval™ Coordinate Measuring Machine without difficulty. (She learned how to use the CopyCAD system in approximately 20 minutes.) She then transferred the digitized data into a part file in CADKEY 3.

On February 23, 1990, Drew Santin, Jay

Jacobs and Rich Millett of SANTIN ENGINEERING, INC., Beverly, Massachusetts, brought Ruth Ann's project into its manufacturing phase. SANTIN ENGINEERING provides product-development support services for plastic-part designers. This includes the building of engineering models; the building of prototype and production injection molds; the casting of urethane prototypes, and the building of prototypes using stereolithography. CADKEY 3 is the company's standard CAD software, supplied by Computer-Aided Products of Marblehead, Massachusetts. Ruth Ann's project interested SANTIN because the complexity of the surface of the human head makes it a very difficult shape to model using a PC-based CAM system. After determining that the head could be machined from digitized data, Rich set out to create the head model, in slices, as economically as possible.

SANTIN ENGINEERING decided to machine the head out of 3/8-inch thick, commercially available acrylic, despite acrylic's brittleness, because Ruth Ann needed a transparently clear head to make it easier for patients to visualize the location of their pain. After machining, acrylic can be polished to optical clarity. Standard 3/8-inch acrylic was sufficiently accurate and would make the project cost effective.

Using CADKEY 3, Rich's first task was to manipulate the splines in Ruth Ann's digitized model into simpler spline contours that would be easier to machine. He mirrored the data into a full three-dimensional head. He then created a user-defined view of the data in CADKEY 3 with the head lying on its left side.

Rich divided the head into five sections to make it easier to create machining toolpaths: (1) Top of the head, (2) Front of the ear through eye and nose, (3) Back of the ear through behind the head, (4) Under the ear to the jaw, and (5) Under the ear to the back of the neck. Because fine detail-work around the nostrils, lips and ears would require excessive machining, with Ruth Ann's approval, Rich made

(Continued on page 14.)

### CADKEY/DataCAD Training in U.S. & Canada (continued)

State	CTC	Location/Contact	Course	Dates
Colo.	University of Colorado at Denver	1200 Larimer St. Denver, CO Andreas Vlahinos (303) 556-2370	Intro. to CADKEY	May 21-22
			CADL	May 23-24
			Integration of CADKEY & FEA	May 25
Conn.	Central Connecticut State University	1615 Stanley Street New Britain, CT Paul Resetarits (203) 827-7262	Intro. to CADKEY	May 21-23
			Advanced CADKEY	Aug. 13-15
			CADKEY	May 24-25
	Datamat Programming Systems	9 Mott Avenue Norwalk, CT Matt Reuben (203) 855-8102	Intro. to CADKEY	Aug. 16-17
				Jun. 4-8
University of Hartford	S.I. Ward College of Technology 200 Bloomfield Av. W. Hartford, CT Don De Bonee (203) 243-4763	Intro. to CADKEY	Mon. & Wed. May 21 to Jul. 12	
			Wed. Sept. 5 to Dec. 12	
Fla.	Indian River Community College	3209 Virginia Ave. Ft. Pierce, FL Dean Zirwas (407) 468-4700, x4269	Intro. to CADKEY	May 7, 9-14, 16
Ill.	PFB Concepts	2525 E. Oakton Av. Arlington Heights, IL Bob Konczal (708) 640-1853	Intro. to CADKEY	May 9-11
				Jun. 6-8
				Jul. 11-13
				Aug. 8-10
			Advanced CADKEY	May 23-25
				Jun. 20-22
				Jul. 25-27
				Aug. 22-24
			CADKEY SOLIDS	May 17-18
				Jun. 28-29
	Jul. 19-20			
	Aug. 16-17			
	CADL	Jul. 7-8		
	PageMaker & CADKEY	Jun. 14-15		

**QUIZ:** Which input method offers greater productivity?

<b>MOUSE</b>	<b>CLICK</b> ■ <b>CLICK</b> ■ <b>CLICK</b> ■ <b>DONE</b>
	<b>CLICK</b> ■ <b>DONE</b>

**answer:**  DIGITIZER TEMPLATE  
 JENSEN PROPERTIES, INC. ■ P. O. BOX 470368 ■ TULSA, OK 74147  
 TEL: 1-(918) 627-5770 ■ FAX: 1-(918) 663-4939

State	CTC	Location/Contact	Course	Dates
Ill.	Triton College	2000 Fifth Av. River Grove, IL Employee Development Peggy Hosty (312) 456-0300, x539	<i>Intro. to CADKEY</i>  <i>Intermed. CADKEY</i>	May 16-18, May 22 to Jun. 7 Sat. Jun. 2-23 Sat. Jul. 14-Aug. 4
Mass.	Springfield Technical Community College	1 Armory Square Springfield, MA William White (413) 781-7822	<i>Intro. to CADKEY</i>	Jun. 11-13
Md.	Anne Arundel Community College	101 College Parkway Arnold, MD Sina Sepehri (301) 541-2435	<i>Intro. to CADKEY</i>	May 21-24 Aug. 13-16
	Catonsville Community College	800 South Rolling Rd. Catonsville, MD Tom Barrett (301) 455-4298	<i>Advanced CADKEY</i>	May 23-25
Mich.	Future Solutions	5900 N. Lilley Rd. #101 Canton, MI Paul Zwarka (313) 981-7455 FAX: (313) 981-7473	<i>Intro. to CADKEY</i>  <i>Advanced CADKEY</i>	May 1-3 May 29-31 Jun. 26-27 May 8-9 Jun. 4-5
Minn.	Albert Lea Technical Institute	2200 Tech Dr. Albert Lea, MN Larry Gilderhus (507) 373-0656	<i>Intro. to CADKEY</i>  <i>Advanced CADKEY</i>	Scheduled on request.
	Moorhead State University	Indust. Studies Dept. Moorhead, MN Wade Swenson (218) 236-2466	<i>Intro. to CADKEY</i>	Jun. 6-8
	St. Paul Technical Institute	235 Marshall Ave. St. Paul, MN Michael Haffner (612) 221-1307		Call for schedule
Mo.	University of Missouri at Rolla	106C Mech. Engr. Rolla, MO Terry Lehnhoff (314) 341-4632	<i>Intro. to CADKEY</i>	May 3-4
Mont.	Montana Tech	W. Park Street Butte, MT Dick Johnson (406) 496-4452	<i>Intro. to CADKEY</i>	May 17-18
N.C.	Entré Computer Center	110 Charlotte Plaza Charlotte, NC John Murphy (704) 332-1557	<i>DataCAD I</i> <i>DataCAD II</i> <i>DC Modeler</i>	Scheduled on request.
	Rockingham Community College	P.O. Box 38 Wentworth, NC Jim Putnam (919) 342-4261, x157	<i>Intro. to CADKEY</i>	May 2-4

some minor modifications to those areas of the head to eliminate any extra machining. He programmed his toolpaths for each of the five sections so that the cutter would begin each path in the middle of the head, at an imaginary vertical line running top-to-bottom. That way each toolpath would end at the front or at the back of the head. This would minimize the possibility of excessive cutter vibration and possible chipping of the acrylic. Then, Rich cut the slices.

### Ready to Go - - New Role for Perceptor

After polishing and assembly, SANTIN delivered the head on April 5, to Ruth Ann. It is now ready for her to use with patients. In the head's day-to-day use, the Perceptor now takes on a new role. After a patient has identified a level on the head model at which he feels headache pain, he will proceed, level by level, to draw on the acrylic slices the location(s) where he experiences pain. These drawings will provide data as to the depth of pain within the head. Once this is completed, Ruth Ann will use the Perceptor's stylus to trace out and digitize the 2-D drawings on each respective level. The data provided through the Perceptor will create a three-dimensional representation of the pain as a part file in CADKEY 3. Using CADKEY SOLIDS on this part file will allow Ruth Ann to calculate the mass properties of the pain, specifically its volume and its centroid. "It is the centroid that will be used as the focal point of each pain region described by the patient," Ruth Ann said.

Dr. Egilius L.H. Spierings had commented about Ruth Ann's project, during its early phase, in the Headache Research Foundation's newsletter dated Spring 1989. Dr. Spierings described her work in such an unexplored field as a fantastic opportunity. "In medicine, we often work from our own concepts rather than from patient experience," Dr. Spierings said. "There can be a discrepancy between our concepts and reality. Unconventional means of addressing headache may provide new clues to other mechanisms that may operate in producing headaches."

## Speed Ski Helmet

(Continued from page 6.)

which the head data, the inner helmet data, and the outer helmet data were superimposed one upon the other. One critical reason for producing this file of superimposed data was to verify that a visor on a safe aerodynamic helmet would provide an adequate field of vision for a speed skier traveling downhill in the *tuck* position. An aerodynamic helmet would be most effective when the skier is traveling in the tuck position because in that position a skier's body is most aerodynamically disposed and creates the least wind resistance.

This new part file of superimposed data suggested to Steve, Braxton, Gary and Ujjwell that the Bell SR2 helmet could be modified into a safe aerodynamic helmet by adding a clear visor and a fairing. The addition of the visor did not pose any particular problem. The fairing was another matter. The fairing's shape in the CADKEY part file is composed primarily of 3-D splines. The fairing starts from both ears and the back of the neck, and flares out over the shoulders and upper back. If SS PEP could get the fairing manufactured so that it would fasten securely to the Bell SR2, but in such a fashion that it could break away if necessary, they would have their innovative yet economically feasible prototype.

## FastSURF

The fairing is a geometrically complex shape. It would require numerical control machining. But, before it could be machined, the fairing's geometries would have to be transformed into a free-form surface using another CADKEY third-party product: FastSURF™. Steve and Braxton chose FastSURF by Fastcut NC Services of Carson, California, for two reasons. First, Fastcut NC Services is one of the enterprises that, like CADKEY, had expressed support for SS PEP's project. Secondly, FastSURF works directly with CADKEY 3 software. (Fastcut NC Services is a CADKEY Exclusive Solution Partner.) Because FastSURF's user interface is written in CADL™

(Continued on page 16.)

## CADKEY/DataCAD Training in U.S. & Canada (continued)

State	CTC	Location/Contact	Course	Dates
N.C.	Wake Technical Comm. College	9101 Fayetteville Rd. Raleigh, NC Brian Matthews (919) 772-0551, x172	<i>Intro. to DataCAD</i>	(11-week, Spring, eve. course) Summer
N.Y.	Iona College	725 North Avenue New Rochelle, NY Flory Netsch (914) 235-1360	<i>Intro. to CADKEY</i> <i>Intermed. CADKEY</i>	Jul 12 May 29
Ohio	CAD CAM, Inc.	2844 East River Rd. Dayton, OH Stephen Bishop (513) 293-3381	<i>Intro. to CADKEY</i> <i>Advanced CADKEY</i>	May 7-9 May 28-30 Jun. 11-13 Jun. 25-27 May 10-11 May 31 - Jun. 1
	Progressive Computing	6964 Spinach Dr. Mentor, OH Mark Orzen (216) 255-0460 FAX: (216) 255-0605	<i>Intro. to CADKEY</i> <i>Advanced CADKEY</i> <i>CADL</i> <i>CADKEY</i> <i>MACROS</i> <i>CADKEY</i> <i>SOLIDS</i>	May 1-2 Jun. 5-6 Jul. 9-10 May 8-9 Jun. 12-13 Jun. 19-20 Jul. 24-25 May 29 Jun. 21 May 22-23 Jul. 30-31
Okla.	Oklahoma State University	301 Cordell South Stillwater, OK Gerald McClain (405) 744-5709	<i>Intro. to CADKEY</i> <i>Intermed. CADKEY</i>	Jun. 13 Jun. 14-15
Ore.	Rogue Community Collge	3345 Redwood Hwy. Grants Pass, OR Del Harris (503) 479-5541	<i>Intro. to CAD/CAM</i>	Jun. 7-8
Pa.	Edinboro University of PA	G-34 Hendricks Hall Edinboro, PA Peter Mathews (814) 732-2592	<i>Intro. to CADKEY</i>	May 21-23 Aug. 13-15
	Micro Control Inc.	390 Middletown Blvd Langhorne, PA Marion Homan (215) 752-5510	<i>Intro. to CADKEY</i>	May 15-18 Jun. 12-15
	Penn. State Univ. at Erie, Behrend College	Station Road Erie, PA. Pat Espin (814) 898-6103	<i>CADKEY</i> <i>SOLIDS</i>	May 31 to Jun. 1
	Wilkes University	Stark Learning Ctr. Wilkes-Barre, PA Michael Petyak (717) 824-4657	<i>Intro. to CADKEY</i>	May 21-23

## CADKEY/DataCAD Training in U.S. & Canada (continued)

State	CTC	Location/Contact	Course	Dates
S.D.	Northern State College	Box 705 Aberdeen, SD Jerry Sauer (605)622-2571	<i>Intro. to CADKEY</i>	May 28-29 Jul. 9-13
Texas	MLC CAD Systems	5316 Highway 290 West Austin, TX Pat Stutz (512)892-6311	<i>Intro. to CADKEY</i> <i>Advanced CADKEY</i>	May 23-25 Jun. 27-29 <i>Scheduled on request</i>
	Texas A&I University	Campus Box 203 Kingsville, TX Herchel Kelley (512)595-2608	<i>Intro. to CADKEY</i>	May 29-31
	Texas Tech University	P.O. Box 4200 Lubbock, TX Mary Bentancourt (806)742-3451	<i>Intro. to CADKEY</i>	May 15-17 Aug. 21-23
Utah	Salt Lake Com m. College	4600 S. Redwood Rd. Salt Lake City, UT Gary Poulsen (801)967-4303	<i>Intro. to CADKEY</i>	<u>Mon. - Wed.</u> afternoons: May 2 to Jun. 6
Va.	Republic Research Training Center	855 West Main St. Charlottesville, VA Gregg Kendrick (804)296-9747 (800)476-4454	<i>DataCAD I</i> <i>DataCAD II</i> <i>DataCAD 3-D</i>	May 9-11 May 17-18 May 14-15
Wis.	Milwaukee School of Engineering	1025 N. Milwaukee St. Milwaukee, WI Marvin Bollman (414)277-7357	<i>Intro. to CADKEY</i>	Jun. 6-8
	North Central Technical College	1000 Campus Dr. Wausau, WI Michael Clark (715)675-3331	<i>Intro. to CADKEY</i>	May 29-31 Aug. 8-10 Additional courses on request.
Wyo.	University of Wyoming	3085 Engineering Bldg. P.O. Box 3295 Laramie WY Donald Polson (307)766-6450	<i>Intro. to CADKEY</i>	May 23-25 Jul. 25-27 Aug. 20-22

## CANADA

Prov.	CTC	Location/Contact	Course	Dates
Nova Scotia	Technical University of Nova Scotia	P.O. Box 1000 Halifax, N.S. Gary Bustin (902)420-7764	<i>Intro. to CADKEY</i> <i>Advanced CADKEY</i>	May 7-9 Jul. 9-11 May 14-15 Jul. 16-17
Ontario	Algonquin College	200 Lees Avenue Ottawa, Ontario Peter Casey	<i>Intro to CADKEY</i> <i>Advanced CADKEY</i>	Jul. 11-13 Jul. 18-20

## Speed Ski Helmet

(Continued from page 15.)

(CADKEY Advanced Design Language), FastSURF operates as a seamless extension of CADKEY 3. With help from Fastcut personnel, Steve and Braxton created the free-form surface of the fairing themselves.

## RLS Enterprises and Bell Helmets

RLS Enterprises of Burbank, California, another SS PEP supporter, and also a CADKEY user, checked the helmet's part file in CADKEY, and then used a CADL file to create the machining toolpath for the fairing on their PC-based CAM system. RLS machined the part using a polyurethane that is formulated to their proprietary specifications. The machined part served to create a mold of the fairing, that Steve and Braxton took to Bell Helmets in Norwalk, California, another supporter of the SS PEP project.

Steve and Braxton arrived at Bell Helmets on February 15, six days before their target deadline. Two days later, Bell Helmets had manufactured the visor and the fairing and had attached them to the helmet. SS PEP now had its physical prototype of a safe aerodynamic helmet for speed skiers. Bell Helmets shipped the helmet to Steve McKinney, coach of the U.S. Speed Skiing Team, for delivery on February 20, 1990.

## Latest Developments

Further dramatic developments have taken place since February. Plans to create a *smart helmet* with sensing devices and visual-display capabilities imbedded in the helmet have progressed more rapidly than originally anticipated. SS PEP has submitted formal proposals to the U.S. Olympic Committee to have their aerodynamic safety helmet approved for use in Olympic competition, and to have *smart helmets* accepted, as well.

Structural Research and Analysis Corporation of Santa Monica, California, another SS PEP supporter, is creating a



fluid-flow-analysis model of the helmet using CADKEY's 3-D data. This model will be used, in conjunction with wind-tunnel testing, to verify the aerodynamic qualities of the helmet's design in preparation for manufacturing a working prototype.

SS PEP's physical prototype helmet will be on display at the **Assault on Velocity Peak** ski competition to take place in Silverton, Colorado, May 5-15, 1990.

**Editor's Note:** For additional information about SS PEP and its technology team, contact SS PEP, 4202 Sierra Morena Avenue, Carlsbad, CA 92008. Telephone: (619) 729-1683.

### THIRD-PARTY NEWS

## CK/MOLD DESIGN™ Introduced at NDES '90 and at PLASTICS FAIR!

MarkeTech Systems, a CADKEY Exclusive Solution Partner, introduced a new product to automate the design of plastic injection molds, CK/MOLD DESIGN™, at the NATIONAL DESIGN ENGINEERING SHOW (NDES), Feb. 26-Mar. 1, and at the PLASTICS FAIR, Mar. 13-15, both in Chicago, Illinois.

Written in CADL™ (CADKEY Advanced Design Language), CK/MOLD DESIGN allows a mold designer to generate mold components parametrically through a CADKEY-like menu structure that appears to the user as a seamless extension of CADKEY. Mold designers can create standard A and B-series moldbases instantly, or they can create customized moldbases by entering user-specified parameters. CK/MOLD DESIGN displays complete plan views of cavities and cores. Assembly sections and end views show only component centerlines and chamfered plate elevations.

CK/MOLD DESIGN eliminates many repetitious tasks through an extensive library of mold components included with the program: ejector pins, core pins, ejector-pin sleeves, socket-head-cap screws, flat-head-cap screws, stepped and straight leader pins, eyebolts, NPT plugs and pipes,

### CADKEY/DataCAD Training in U.S. & Canada (continued)

Prov.	CTC	Location/Contact	Course	Dates
	JB Marketing Associates	82 Spruceside Cresc. Fonthill, Ontario John Bradford (416)892-8025	<i>DataCAD I</i> <i>DataCAD II</i>	Scheduled on request.
	Klear Concept Data	465 Rogers St. Peterborough, Ontario John Punshon (705)742-3354	<i>Intro to</i> <i>CADKEY</i>	Scheduled on request.
	Naylor- McLeod Group	1425 Bishop St. Cambridge, Ontario Brian Naylor (519)622-4495	<i>Intro. to</i> <i>CADKEY</i>	Scheduled on request.

### Announcement Of Training Dates

If you are a CADKEY or DataCAD Training Center and would like the dates of your scheduled training courses to appear in **3-D WORLD**, contact Peter Mancini, Educational Programs, CADKEY, INC., 440 Oakland Street, Manchester, CT 06040-2100. Telephone: (800) 654-3413 or (203) 647-0220. FAX: (203) 646-7120.

bushings, locating rings, sprue bushings, parting-line locks, springs, support pillars, slide retainers, and more. CK/MOLD DESIGN also generates title blocks, detail notes, and revision boxes. Because CK/MOLD DESIGN is a powerful parametric program, rather than just a library of pattern files, it requires only a small amount of hard disk space (less than 500K).

Glenn Starkey of MarkeTech Systems indicated that CK/MOLD DESIGN received a warm welcome in demonstrations and in a "hands-on" training session from attendees at the CADKEY MANUFACTURING SOLUTIONS FAIR at NDES '90.

For additional information about CK/MOLD DESIGN, contact MarkeTech Systems, Unit 104-B, 1000 Rand Road, Wauconda, IL 60084. Telephone: (708) 356-2600. FAX: (708) 453-6100.

### CADKEY Provides Training for Soviet Refugees

(Continued from page 11.)

Pam Garry, Vocational Counselor in the Resettlement Program sponsored by the Jewish Family Service of Greater Hartford, said that, as a direct result of the program, two of the refugees have already found employment.

The CADKEY volunteers who conducted the program were Jimm Meloy, Jeff Hall, Jay Hirth, Paul Resetarits and Peter Smith. Commenting about what he and the other volunteers did, Peter Smith, Chairman of CADKEY's Board of Directors, said, "If we can help these engineers realize their dream and enhance our industry with new professionals, then we can certainly be proud of our program."

# NETWORKING CADKEY?

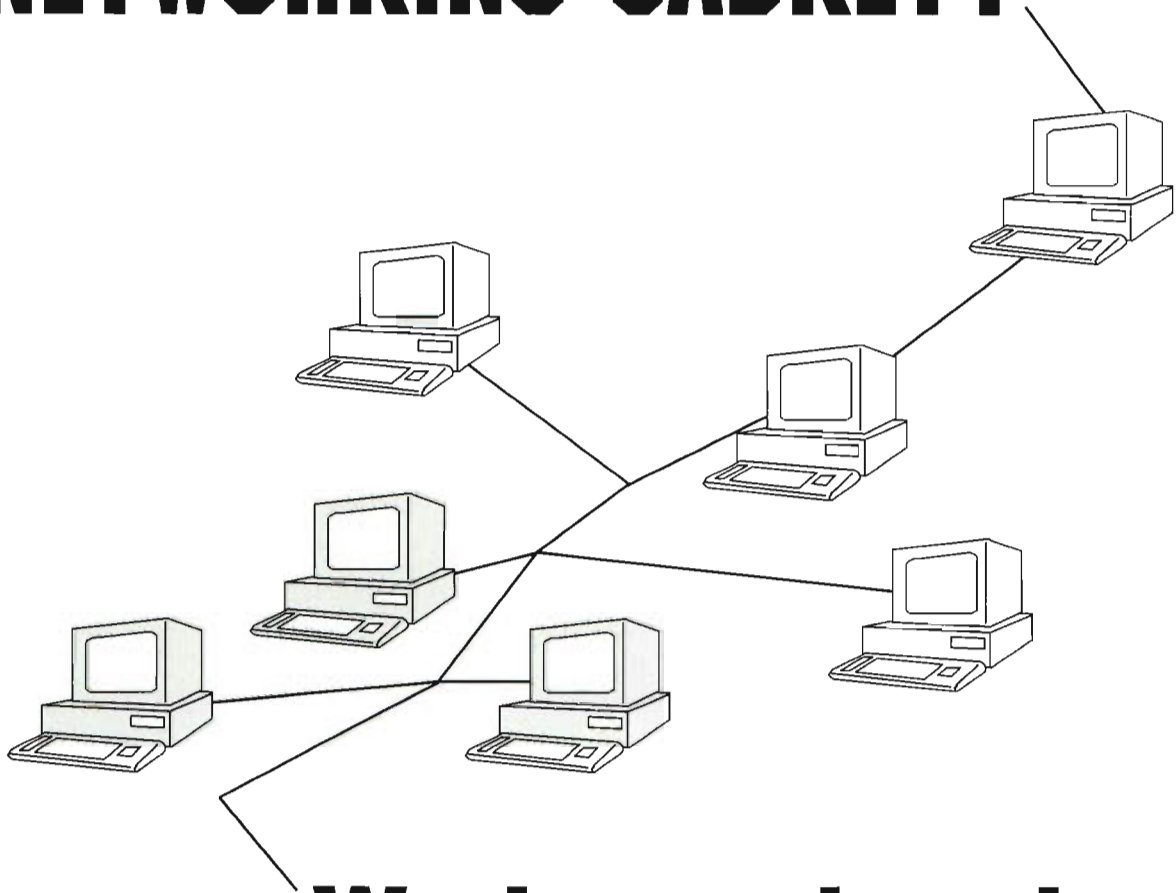

## We know how!

COME SEE HOW IT'S DONE at Cadkey Corporate Headquarters  
on **May 16** in Manchester, Connecticut

Micro Engineering Solutions, the leader in Cadkey networking, will demonstrate their full-featured networking technology for Cadkey with capabilities *you thought were impossible!*

**Make your reservation today! Call 1-800-966-4CAD**



MICRO ENGINEERING SOLUTIONS, INC.  
CAD / CAM System Integrators

## La Technothèque

(Continued from page 20.)

support to the center.

### Real Strength

La Technothèque's real strength lies in the multi-disciplined technical expertise of its staff, headed by Noël Scherer and Georges Rennotte, who guide their clients in obtaining the information, training, or research that they seek.

Individuals may use any of the hardware or software that the center has, but it must be used at La Technothèque. They can do comparative studies of software products from different vendors that apply to a particular area of technology of interest to them. "For people who are in the process of inventing a new product or process, but who do not have equipment available," said Georges Rennotte, Assistant Director and CAD/CAM specialist, "they can use the center's CAD and CAM equipment to develop their project, and even to manufacture a prototype, so long as they supply their own material or components for manufacturing."

### Busy Place

La Technothèque is a busy place. The center occupies a very pleasantly renovated, conveniently accessible, three-story building in downtown Liège. During the mornings, Monday through Friday, the center conducts small-group training or customized problem-solving workshops in particular technologies that individual companies or organizations have scheduled ahead of time with the center's staff. During the afternoons and Saturday mornings, the center is open to the general public similar to a public library. Every Thursday evening there are seminars and

workshops presented by individual hardware or software vendors. "These Thursday evening sessions are always presented from the point of view of learning, not competition," Mr. Rennotte emphasized.

### Three Groups of Users

La Technothèque serves three basic groups of customers: (1) people who are seeking technical information of a general nature or related to a specific topic; (2) people who want rapid training in a particular computer-related technology; (3) people who use the center as a regular resource for self-improvement with highly competent technical assistance available if needed. Clients come from widely diverse backgrounds and levels of expertise: people seeking employment or new careers, people working to advance in their current careers, teachers, technicians, engineers, research professionals, students from secondary schools, colleges, and universities.

### Statistics of Service

In 1989, visitors seeking general or specific information comprised 42% of the center's clients; people wanting rapid training represented 17%, and frequent regular visitors accounted for 41%. The average number of visits by frequent regular customers (10 visits or more) amounted to 22 visits per person. In 1987, the center's register recorded 924 visitors. In 1988, the number of clients increased to 2,329. In 1989, 13,600 people made use of La Technothèque's facilities and services. "That is 60 people a day," Mr. Rennotte said. It is important to note that these numbers represent people who visited La Technothèque as individuals during the 30 hours per week, Monday-through-Friday afternoons and Saturday mornings, when the center is open to the general public to walk in.

## Mark of Success

La Technothèque has become so successful that the Belgian government is exploring how to replicate this concept in other cities. There have even been expressions of interest from other members of the European Community.

**Editor's Note:** For more information about La Technothèque, contact Noël Scherer or Georges Rennotte, La Technothèque, 135 D, Boulevard de la Sauvenière, B 4000 Liège, Belgium. Telephone (from outside of Belgium): 32-41-23-18-76. FAX: 32-41-23-64-98.

## CADKEY, INC. Reaffirms Long Partnership With Central Connecticut State University

CADKEY, INC. demonstrated its interest in attracting more students to *high-tech* careers by funding a comprehensive informational booklet describing the 22 concentrations in technical education at the School of Technology of Central Connecticut State University (CCSU), in New Britain, Connecticut.

Peter Smith, Chairman of the Board, and Livingston Davies, President, presented a check for \$5,000 to Dr. John R. Wright, Dean of the School of Technology. CADKEY's award will enable the eight-year-old school, Connecticut's only publicly-funded, four-year, higher-education program in technology, to produce a complete booklet of its programs for the first time.

"We have worked with CCSU since 1985," Peter Smith noted, "and we are proud to have an active CADKEY Certified Training Center on the university's campus. The School of Technology has a lot of impressive growth ahead of it, and we want to help promote that growth by making this gift."

# CADKEY, INC.

440 Oakland Street  
Manchester, CT 06040-2100

BULK RATE  
U. S. POSTAGE  
PAID  
PERMIT NO. 1784  
HARTFORD, CT.

02809535MINC\*1>  
ANTHONY A. NUNES, INC.  
GENERAL CONTRACTORS & BLD  
535 METACOM AVENUE  
BRISTOL RI 02809

## La Technothèque - - A Unique Technology Resource in Belgium!

The industrial city of Liège, Belgium, approximately 60 miles East of Brussels, houses a unique learning center, technical library, and collection of up-to-date computer hardware and software called La Technothèque. Paul Simar and Noël Scherer, civil servants in the Belgian government's National Employment Office, founded La Technothèque with a government grant in February 1987. The Belgian government continues to sponsor the program. The center's purpose is to provide opportunities for individuals or small groups to obtain information and training in computer-related technologies.

### Three Years Old

The center opened its doors on March 1, 1987. Starting as a technical library, it added personal computers a short time

later to offer its clients *hands-on* experience with different types of software. What makes La Technothèque unique is the fact that it provides all of its services absolutely free of charge! In fact, it is not even necessary for a person to be Belgian in order to take advantage of the center's

subscriptions to technical periodicals, the center includes a technical workshop that contains a variety of numerical-control machinery and programmable robots, as well as data bases of technical instruction. The center now has at least thirty personal computers and workstations with

software available for computer-aided design and drafting, architecture, mechanical engineering, electrical and electronic engineering, robotics, office information systems (word processors, spreadsheets, data bases, etc.), management information systems, planning, graphics, statistics, and desktop publishing.

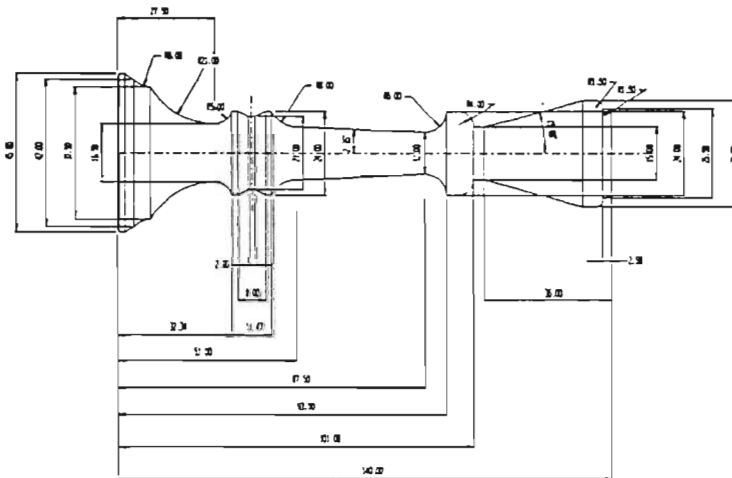

A turning designed at La Technothèque using CADKEY 3.

### CADKEY 3™

facilities! "We are open to anyone, Belgian or non-Belgian, who is interested in learning new technologies," said Noël Scherer, Director of La Technothèque.

In addition to a library of more than 3,000 technical-reference texts, and more than 120

CADKEY 3™ software plays an active role among the various CAD software packages available at La Technothèque. Jos Vliegen and Robert Daubremer of VLECAD, B.V.B.A., a CADKEY dealership in Meeuwen, Belgium, provide technical

(Continued on page 19.)

**3-D World** is published bi-monthly by CADKEY, INC., 440 Oakland Street, Manchester, CT 06040-2100. TELEPHONE: (203) 647-0220. FAX: (203) 646-7120. TELEX: 510 600 7223. If you need additional copies, or if there is a change in mailing address, please contact Frank Simpson, Editor; Maribeth Schneider or Mary Beth Staron, Contributing Editors. © Copyright 1990 by CADKEY, INC. All rights reserved.